

# Robot Vacuum Cleaner User Manual

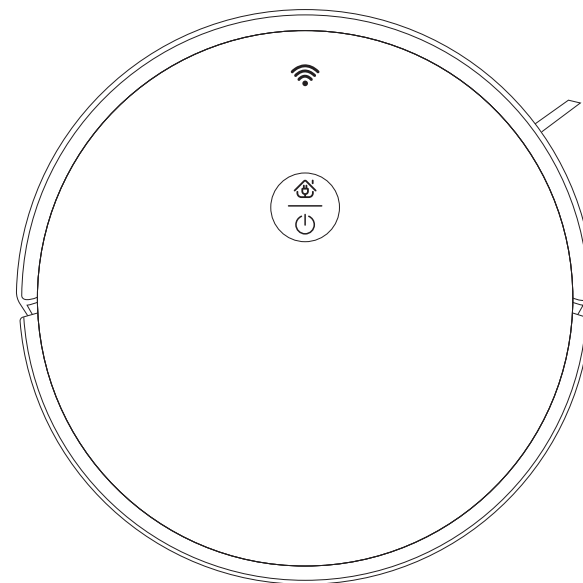

"CE" marking states that the product is compliant to European Directives  
2006/95/CE Low Voltage Directive  
2004/108/EC EMC Directive  
It is possible to request a full copy of Declaration of compliance to the Distributor:  
This product complies with the rules of RoHS Directive(2002/95/CE)  
This product complies with the rules of Eup Directive(2009/1255/CE)

Thanks for choosing our smart robot! Please read this manual before using and keep it properly for later reference.

Hopefully we shall render you a more convenient life of smart home.

This product is subject to the material object. Our company reserves the right to update the product without prior notice.

Best Wishes

Page	Table of contents
1	<b>Safety instruction</b>
3	<b>Product component</b>
3	2.1 Main machine
3	2.2 Rolling brush
4	2.3 Water tank
4	2.4 Dust bin
5	2.5 Charging dock
5	2.6 Remote controller
6	<b>Product parameters</b>
7	<b>Accessories list</b>
8	<b>Safety precautions</b>
9	<b>Operation Instructions</b>
9	3.1 Charging
10	3.2 Start cleaning
11	3.3 Pause cleaning
11	3.4 Install the APP
13	3.5 App user guide
16	3.6 Remote controller function
17	3.7 Set reservations with remote controller
19	3.8 Set reservations with APP
19	3.9 Different cleaning modes
22	3.10 Operation of the water tank
23	<b>Maintenance</b>
23	4.1 Clean the dust bin and filter elements
24	4.2 Clean the water tank
24	4.3 Clean the other components
26	<b>Audible &amp; Visual Alarms</b>
26	5.1 Indicator description
26	5.2 Audible alarms list
27	<b>Troubleshooting</b>
28	<b>Name and content of hazardous substances in product</b>
29	<b>Battery recycling</b>
30	<b>Warranty card/certificate</b>

## Safety instructions

Follow the guidelines

Use the product with consistent vigilance and follow the following guidelines:  
Please read this manual carefully before using the product.  
Keep it properly.

### Attention

- 1.1 Please use the product according to the instructions in this manual. Any operation inconsistent with this manual may lead to the damage of the product.
- 1.2 The product cannot be operated and used by children under the age of 8 or people with mental disorder. If necessary, please use the product under the supervision and guidance of the guardian. Please do not allow children to sit on the product or play with the product as a toy.
- 1.3 Before using the product, please move the power cable and small items on the ground to avoid the product being blocked during cleaning; fold the fringe of the carpet under the carpet and keep the draped curtains, tablecloths, etc. from touching the ground.
- 1.4 If there is a cliff area such as the stair, please test whether the product can detect the edge of the cliff area without falling. If it is necessary to set up a protective fence at the edge of the cliff area to prevent the product from falling, ensure that the protective facilities will not cause tripping and other personal injuries.
- 1.5 Please make sure that the power supply voltage conforms to the voltage marked on the charging dock.
- 1.6 This product is an indoor household product, please do not use it outdoors.
- 1.7 Only the original rechargeable battery and charging dock specially equipped by the manufacturer shall be used. It is strictly prohibited to use non-rechargeable batteries. Please refer to Product parameters for battery specification information.
- 1.8 Please confirm that the dust bin and filter elements have been installed in place.

### Danger

- 2.1 Do not use the product in an environment with open flames or fragile items.
- 2.2 The operating temperature of the product ranges from 0 °C to 40 °C.
- 2.3 Do not let your hair, clothes, fingers and other parts close to the product's intake port when it's working.
- 2.4 Do not use the product in the humid or stagnant environment during the vacuum operation mode.
- 2.5 Do not allow the product to clean any combustible items, such as gasoline, printer or photocopier toner and powder, do not use the product in an area with flammable items.
- 2.6 Do not allow the product to clean any burning items, such as cigarettes, matches, ashes and other items that may cause fire.
- 2.7 Do not place any items at the intake port. Do not use the product if the intake port is blocked. Please clean the dust, cotton wool and hair at the intake port in time.
- 2.8 Please use the power cable carefully. Do not use the cable to drag or pull the product and its charging base. Do not use the cable as a handle. Do not clamp the cable in the door gap. Do not pull the cable at the sharp corner or corner. Do not allow the product run on the cable, and the cable should be away from any heat source.

## Safety instructions

Follow the guidelines

### Attention

- 3.1 If the power cable is damaged, it shall be replaced by a professional from the manufacturer's maintenance department or similar department in order to avoid danger.
- 3.2 Do not use the damaged charging dock.
- 3.3 Do not use damaged cable or power socket to charge the product. Do not use the product when it fails to work properly due to falling, damage, outdoor use or being wet. To avoid injury, the product should be repaired by the manufacturer or its after-sales service department.

### Attention

- 4.1 Always disconnect the robot from outlets and turn off power before cleaning and maintaining it.
- 4.2 Don't let the robot to suction water and other liquids.
- 4.3 Unauthorized removal of the battery is not allowed.
- 4.4 Please clean the hair on the universal caster and brush in time.
- 4.5 Don't let the robot cartwheeled during mopping in case the PCPA plate is damaged due to the water flows over the edges of the tank.
- 4.6 Don't mop on the carpet. Make sure no water stain appears where the water tank is placed.
- 4.7 Always wipe up the water tank after filling it up.
- 4.8 To keep your robot running at peak performance, empty the dust bin in time to avoid a jammed filter.
- 4.9 Before discarding the appliance, disconnect the robot from charging dock, turn off power and remove the battery. Please remove and discard the battery in accordance with local laws and regulations.
- 4.10 Avoid any cold or heat. The robot only work in 0°C to 40°C temperature range.

### Danger

- 5.1 It is forbidden to burn the product even if it is seriously damaged, as the battery may cause an explosion.
- 5.2 If the product is not used for a long time, please power off the product.
- 5.3 Check whether the charger and socket are properly connected, otherwise it may cause fire.
- 5.4 Plug the charger power cable tightly, otherwise it may cause electric shock, short circuit, smoke or fire.
- 5.5 Do not stand or sit on the robot to avoid damage to the robot or personal injury.
- 5.6 Do not touch the power cable when your hands are wet, or it may cause electric shock.
- 5.7 Only authorized technicians can disassemble the product, and users are not allowed to disassemble the product by themselves.

## Product component

Know your product

### 2.1 Main machine

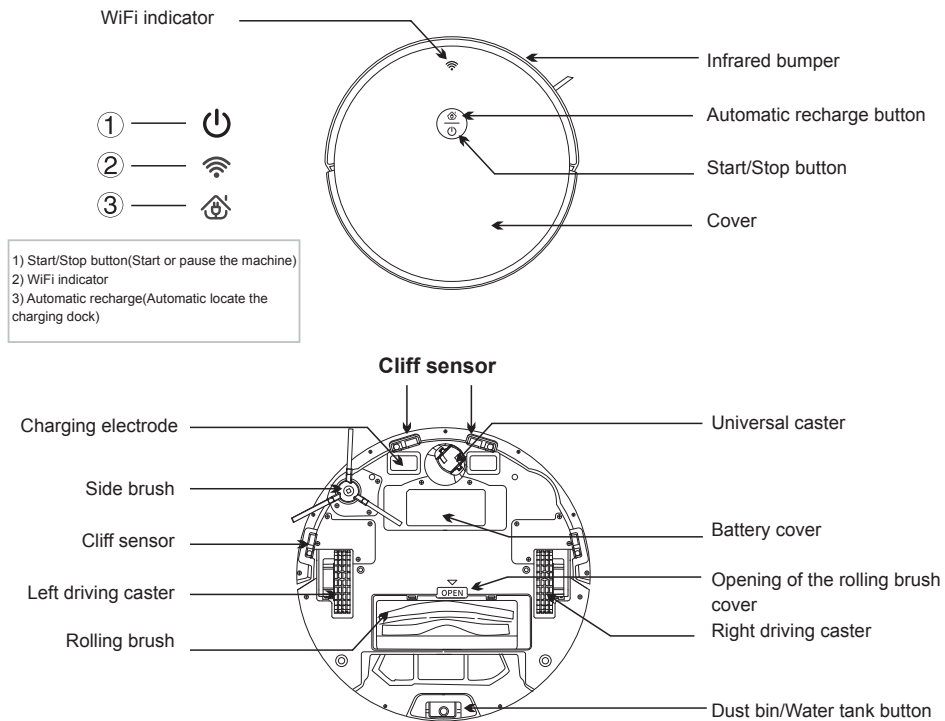

### 2.2 Rolling brush

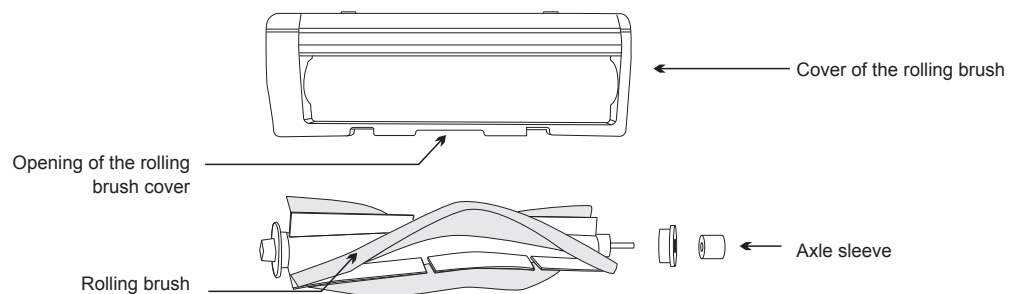

## Product component

Know your product

### 2.3 Water tank

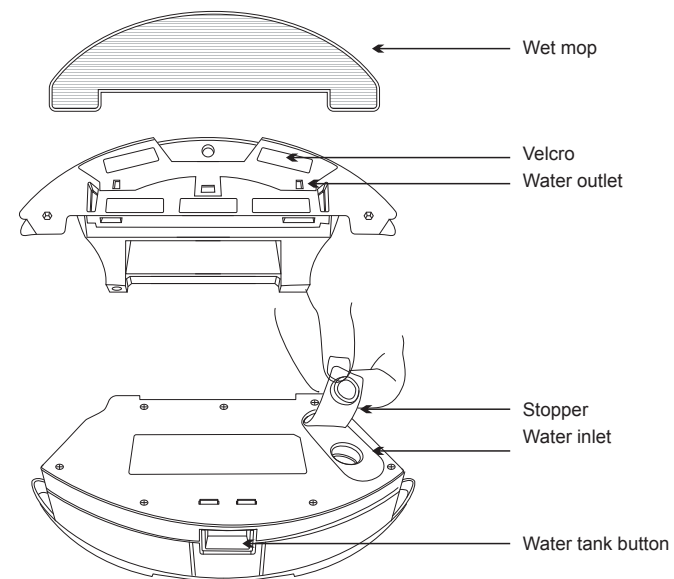

### 2.4 Dust bin

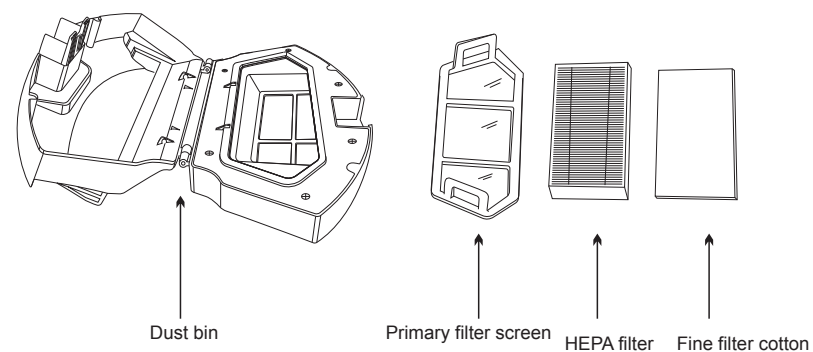

## Product component

Know your product

### 2.5 Charging dock

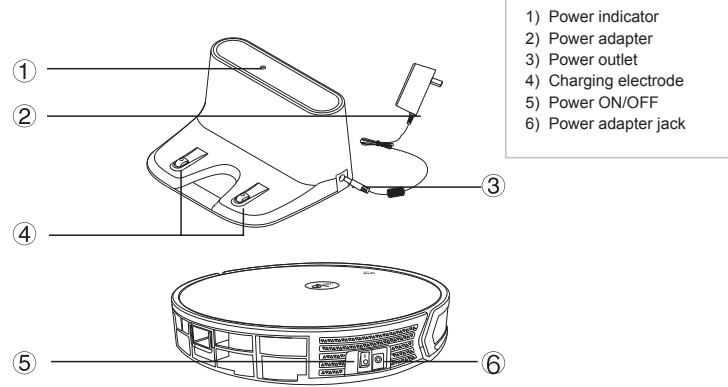

### 2.6 Remote controller

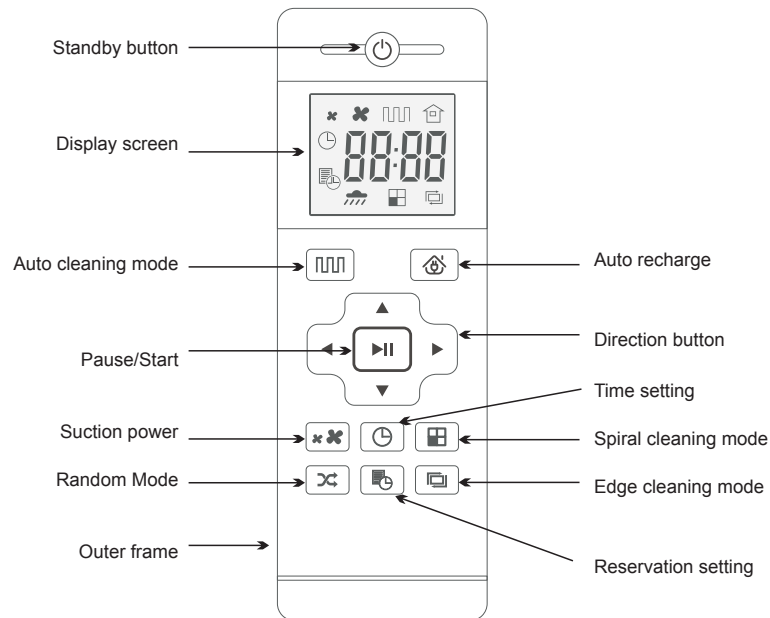

## Product parameters

Know your product

Classification	Item	Specification
Machine body	Diameter	345mm
	Height	76mm
	Net weight	2.8kg
Electronics	Voltage	14.8V
	Battery	Li battery 2,600 mAh
	Power	28W
Cleaning parameters	Dust bin capacity	650ml
	Water tank capacity	350ml
	Charging type	Automatic charging, Manual charging
	Cleaning mode	Auto cleaning, Spiral cleaning, Edge cleaning, Scheduled cleaning, Mopping mode, Manual mode
	Full charge time	About 280mins
	Working time	About 100-120mins
Button type		Physical buttons

\*For the purpose of continuous improvement, all rights to change and interpret are reserved in terms of technology and design regarding the product.

\*The models only differ slightly in color and appearance without other essential difference.

## Packing list

Know your product

### Accessories List

No.	Description	Quantity
1	Main unit(include battery)	1
2	Charging dock	1
3	Remote controller	1
4	Power adapter	1
5	Cleaning brush	1
6	User manual	1
7	Side brush	1
8	High efficiency filter	1
9	Mop	1
10	Dust bin	1
11	Water tank	1

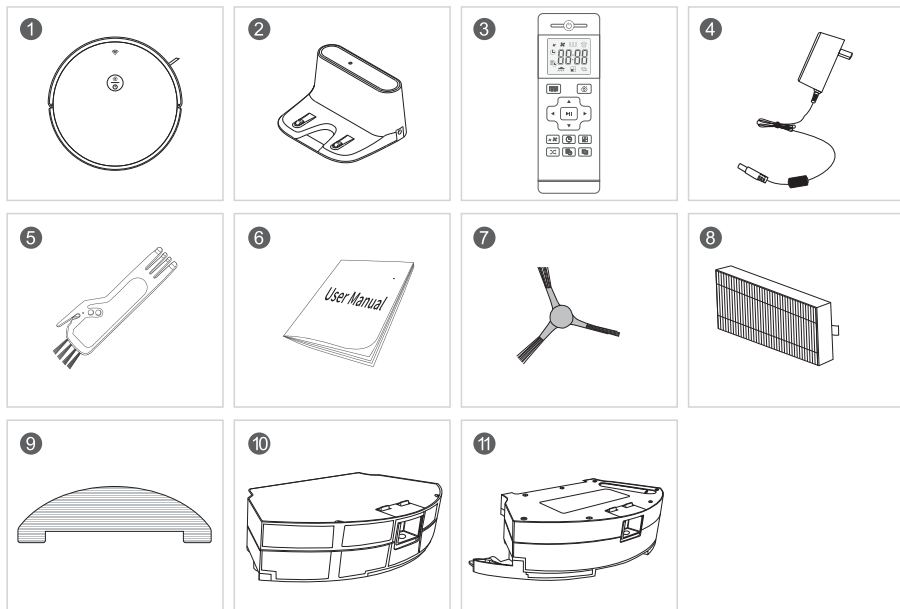

## Precautions

Follow the guidelines

Before the robot works, please refer to the following instructions to check the cleaning area.

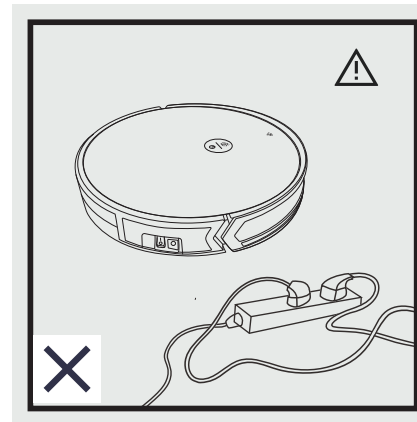

The power cord and other sundries scattered on the ground may entangle or wrap the product. Be sure to remove them before use.

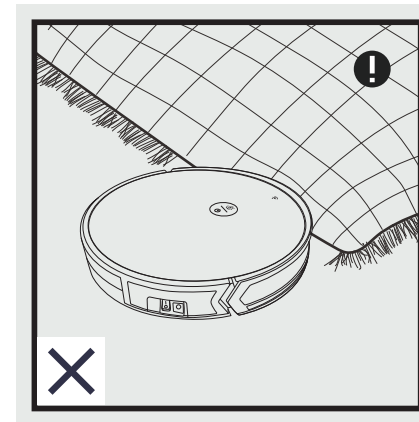

Please roll up the fringe of the carpet or make the product work on the carpet.

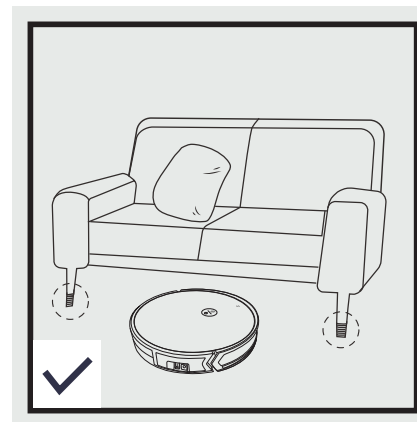

The space less than 8cm at the bottom of the furniture may block the robot. If you need to clean this area, please raise the furniture.

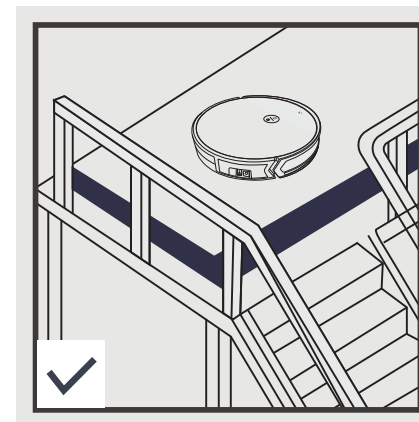

Protective fence shall be placed at the landing to ensure the safe operation of robot.

### 3.1 Charging method

#### 1 Charging dock location

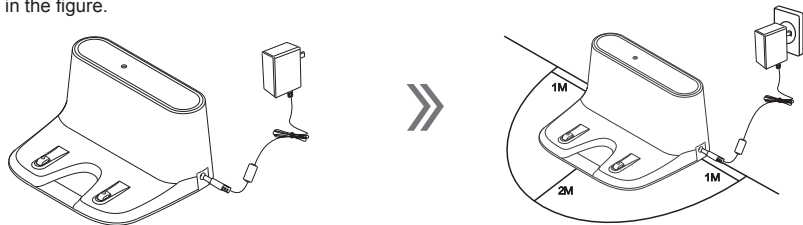

Place the charging dock on the flat ground with the back against the wall, and remove all obstacles around the charging dock of about 1.5 meter in width and 2 meters in front of the charging dock, as shown in the figure.



**\* Notes**

The indicator light on the top of the charging dock will go out during normal charging.

#### 2 Auto charging

- A. If the machine is in low power in auto cleaning mode, it will automatically locate the charging dock for charging.
- B. Press the auto recharge button  on the remote controller, and the machine will automatically locate the charging dock for charging.
- C. Short press the  button on the machine cover, the robot will automatically locate the charging dock for charging.

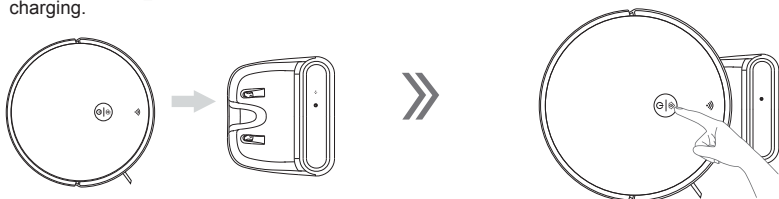

**\* Notes**



For daily use, please clean the charging electrode on the charging dock to increase the effective charging quantity.

#### 3 Manual charging

Turn on the power switch on the side of the robot, and the indicator light of the button on the cover flashes (1 for power on and 0 for power off). Then connect the power adapter to the power supply, and plug the DC output terminal into the robot. (as shown in the figure)



**\* Notes**

- A. Please charge the machine for not less than 12 hours when charging for the first time, and charge it until the red light of the power button  and  breathe. When the battery is fully filled, the green light of the power button  will be constantly on.
- B. For daily use, please store the robot on the charging dock and make sure the charging dock is connected to the power supply.
- C. If you do not use the robot for a long time, please fully charge the robot, turn off the power switch and store it in a ventilated and dry place.
- D. When setting the reservation mode with APP, do not use manual charging mode. It is recommended to use auto charging mode.

#### 4 Install the side brush



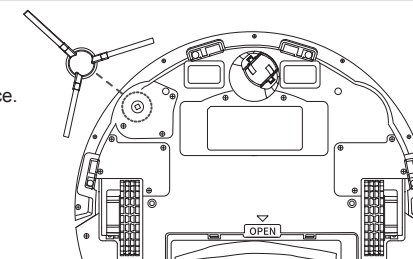

Make sure the side brush is installed in place.

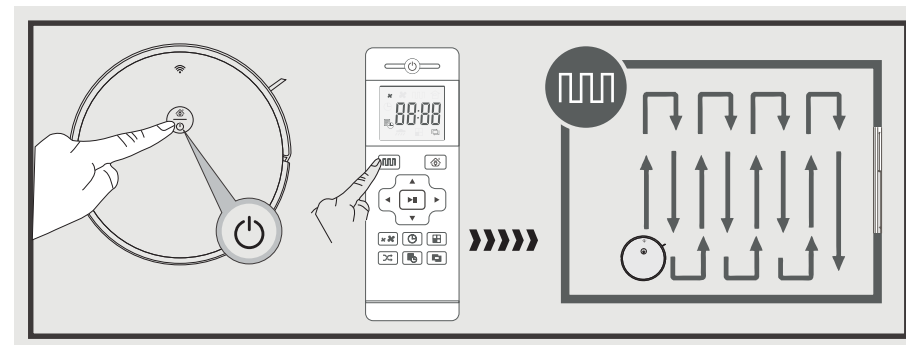

### 3.2 Start cleaning

Short press  button on the machine or  button on the remote controller to start the automatic cleaning mode.





- \* Turn on the power switch on the side of the robot.
- \* Before start cleaning, make sure the machine is activated and the power button  lights green. If the machine is not activated, short press the machine power button  or  button on the remote controller to activate the machine.
- \* The machine will enter sleep mode after 2 minutes idle. The  button and  indicator go out, WiFi is not working. You can select other modes by referring to Production operation-remote controller.

## Product operation

Need to know

### 3.3 Pause cleaning

Short press  button on the machine or  button on the remote controller to pause cleaning.

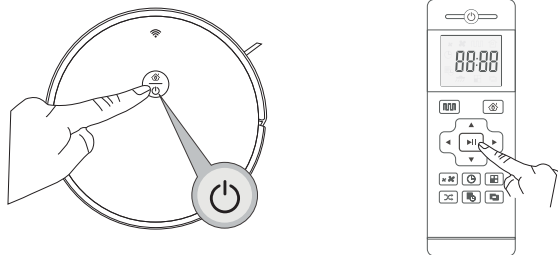

#### \* Notes

- \* If you do not use the product for a long time, please remove the battery and keep it properly. In case of battery leakage, please remove the battery and wipe the battery tank clean.
- \* Only allow the robot to be used in 0°C to 40°C temperature range.
- \* This product uses long-life battery and does not need to be replaced frequently. If you need to replace it, please contact our after-sales service.

### 3.4 Install the APP

This product can be remote controlled by mobile APP. Download the App by scanning the QR code with your cell phone or Search for "Tuya Smart" in the mobile app market and download the app.

★ For more information, please refer to the APP user guide.



## Product operation

Need to know

### 3.5. APP user guide

1. Download the App by scanning the QR code with your cell phone or Search for "Tuya Smart" in the mobile app market and download the app.

Before using this function make sure your cell phone has been connected to WiFi or bluetooth. Only use the 2.4GHz network.

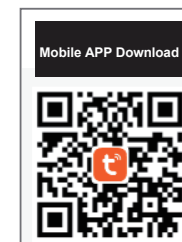

2. Open "Tuya Smart" App and register a new account or use an existing account.

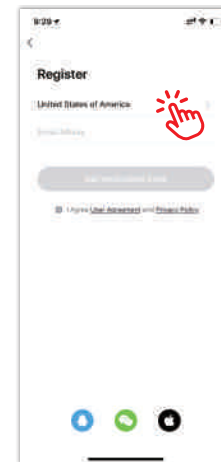
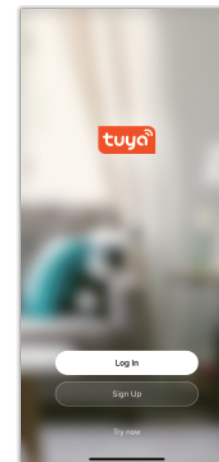

3. After the password is set, proceed to the next step "Add Device"

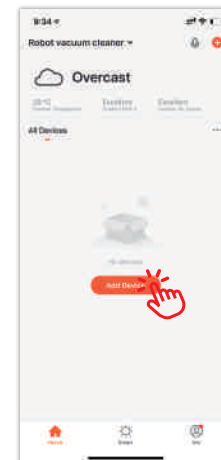
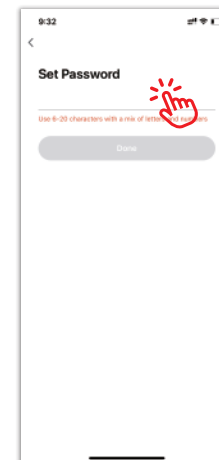



## Product operation

Need to know

4. Select and click on "small Home Appliances".





5. Select and click on "Robot Vacuum".

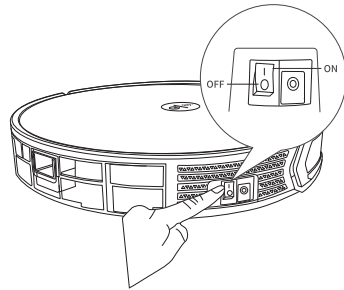

6. Switch on the power button at the side of the machine (1 - ON; 0 - OFF), as shown in the figure.



7. After the start-up tone is finished, long press the  button and  button on the machine cover for more than 5s till the buzzer beeps and  WiFi indicator flashes.

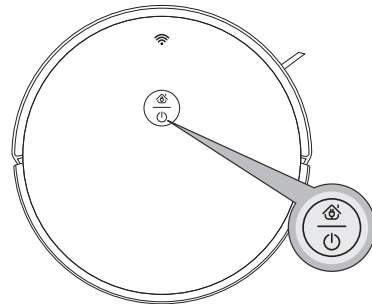

## Product operation

Need to know

8. Select your home WiFi name and enter the WiFi password, then click on NEXT (note: only 2.4G WiFi is available), as shown in the figure.

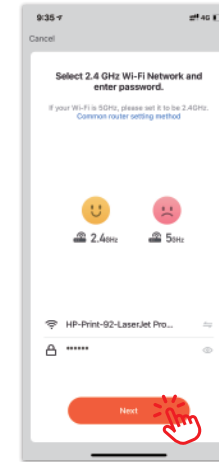

9. Make sure the WiFi indicator is flashing, and check "WiFi indicator rapidly blink", and click on NEXT for network connection - device has been added, then click on OK.

It might take a few seconds to connect the device to WiFi network, depending on the signal strength. A control interface will be displayed when the device is bound successfully.

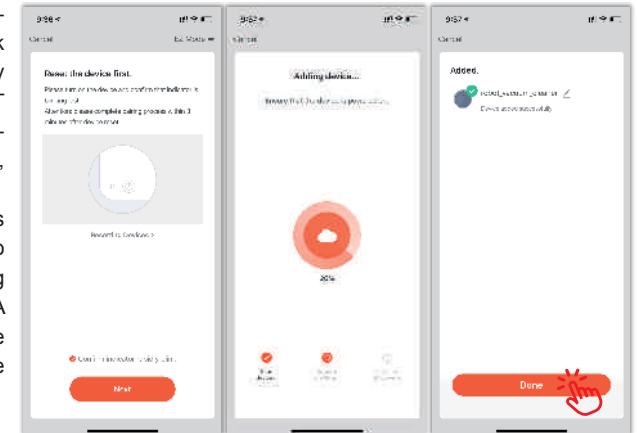

Reset WiFi: In case of connection timeout or before connecting another cell phone, first switch on the device and, within 10 seconds, long press the Start/Stop button for 5 seconds till it beeps, and then re-connect it to WiFi network.

10. Click on "Robot vacuum cleaner", as shown in the figure to enter control interface.

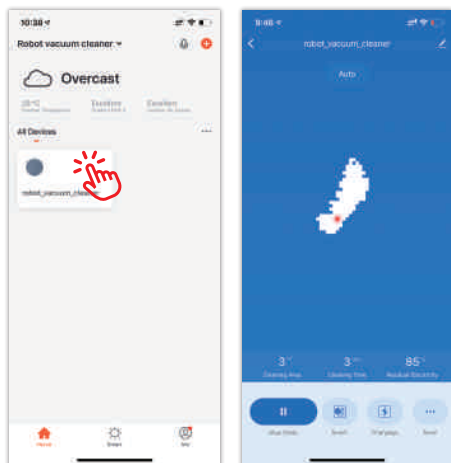

11. A page will be displayed, as shown in the figure, if the device makes no response. Click on " Switch Pairing Mode" to view the reason, or click on "Retry" to add the device again.



12. To unbind the device, click on "Me > Home Management > Home name > Delete Home" at the lower right corner, as shown in the figure. (Note: to re-connect the device after unbinding it, repeat the previous operations)

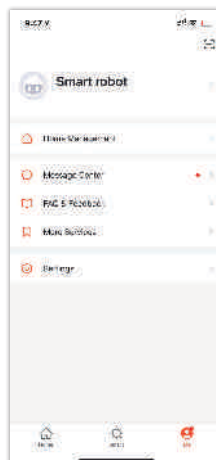

### 3.6 Remote controller function

1 Standby button

Press the button to enter the sleep mode, please press for restarting the machine

2 Auto cleaning mode

Press this button to start cleaning; Press to pause the machine if necessary

3 Automatic recharge

Press this button to automatically locate the charging dock for charging.

4 Stop button

Press this button to stop working. In the sleep status, press this button to restart working.

5 Direction button

A. "▲" Forward

Press this button to increase the number in reservation mode or clock mode. Press this button to move the machine forward in cleaning mode.

B. "▼" Backward

Press this button to decrease the number in reservation mode or clock mode. Press this button to move the machine back in cleaning mode.

A. "◀" Left

Press this button to switch the minute to hour in reservation mode or clock mode. Press this button to move the machine right in cleaning mode.

A. "▶" Right

Press this button to switch the hour to minute in reservation mode or clock mode. Press this button to move the machine right in cleaning mode.

6 Reservation setting

A. Press this button to enter the reservation mode. B. Press the button again to save the settings.

7 Clock setting

A. Press this button to enter the clock setting mode. B. Press the button again to save the settings.

8 Edge cleaning mode

Press this button to start cleaning along the edges.

9 Spiral cleaning mode

Press this button to start cleaning in circles.

10 Suction power

In working status, press this button can select Quiet/Powerful suction.

11 Random Mode

Press this button The machine will perform random direction work.

12 Sleep mode





To put the machine into sleep mode:

A: Press the Standby button;

B: The machine will automatically go into sleep after 2 minutes idle.



### 3.7 Set reservation with remote controller

For facilitating cleaning, the product has the "Reservation" function. Time setting and reservation setting shall work with the instruction to the robot through remote controller. After successful reservation, the robot will perform cleaning task automatically every day according to the setting time.



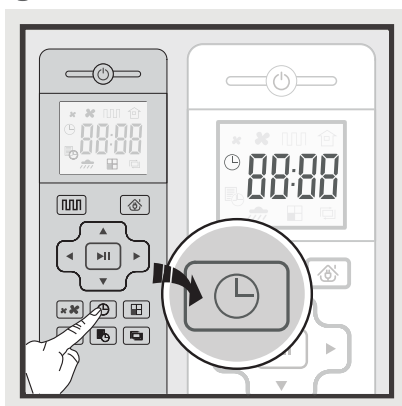

- \* Aim the remote controller at the robot to set Reservation. (Make sure the power switch on the side is on.)
- \* Press  on the remote controller to enter the reservation mode, press the direction key to set the specific cleaning time. The remote controller applies a 24-hour system.
- \* Make sure the green light of  is constantly on and the robot is now awakened. If the robot is not awakened, short press  or the remote controller key  to wake up the robot.

1

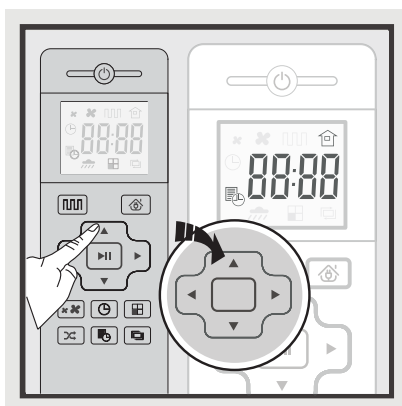



Short press . The icon  will be displayed on the screen and 88:88 flashes on the clock zone.

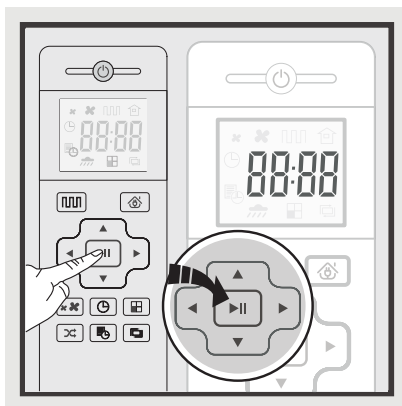

The current time can be set by pressing   to adjust the numbers and pressing   to switch between clock and minute.





Time is adjusted. Press  to save and the icon  in the display screen disappears. Current time is set.

- \* If not press  to save the settings, representing unsuccessful current setting.

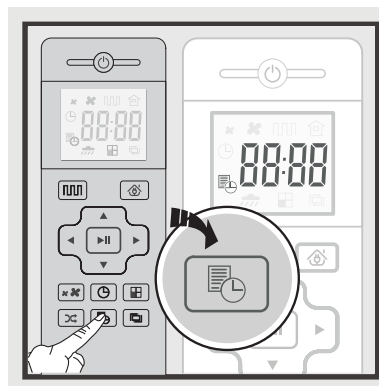
2 Set a specific time



Short press . The icon  will be displayed on the screen and 88:88 flashes on the clock zone.

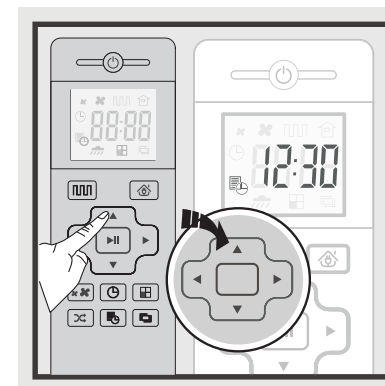

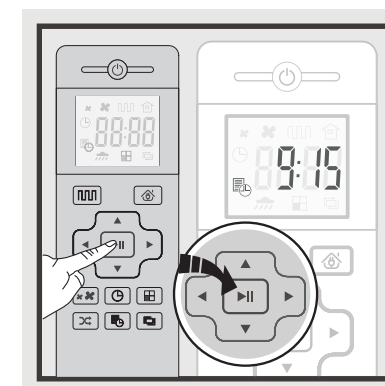

The reservation time is set. Press  to save. The prompt tone of "Di-Di" can be heard. The scheduled cleaning is set. The robot will automatically do the cleaning at the time set. If the power switch is off, the reservation will be cancelled. You need to reset a specific time.

- If not press  to save the settings, representing unsuccessful current setting.



3 Cancel reservation

Long press  for 3 seconds, the icon  in the display screen disappears, the robot issued a prompt tone of "Di-Di", representing the reservation is cancelled.

- \* After changing the battery of remote controller, the current time and reservation time should be reset.

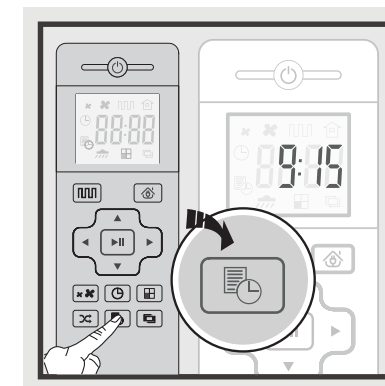

### 3.8 Set reservation with APP

For facilitating cleaning, the product has the "Reservation" function. Scheduled cleaning mode can be set through APP on the phone. After reservation setting, the robot will clean automatically every day according to the setting time. (How to connect the APP please see the instruction in the APP User Guide.)

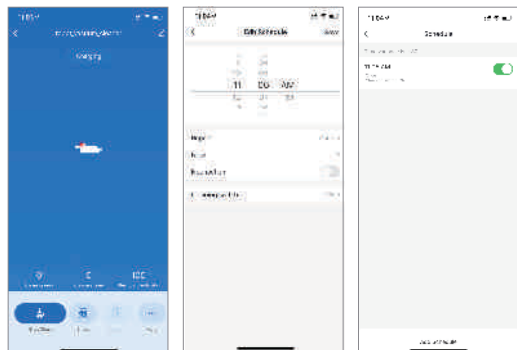

Click "More" in the lower right corner of the APP control interface and select "Timing"

Add and edit a target time

You can cancel the reservation time by closing the reservation item.

Make sure the button on the machine lights green and the machine is now awakened. If the machine is not awakened, short press button on the machine or button on the remote controller to wake up the robot.

### 3.9 Different cleaning modes

In order to suit different house conditions and achieve deep cleaning, the product has a variety of cleaning modes.

- \* Any cleaning modes can be set by using the remote controller or APP.
- \* Make sure the button on the machine lights green and the machine is now awakened. If the machine is not awakened, short press button on the machine or button on the remote controller to wake up the robot.

#### 1 Auto cleaning mode

This is the most commonly used cleaning mode. When you press this button, the machine will start planning for cleaning automatically. It will change direction automatically when encountering obstacles. (press button on the machine or button on the remote controller to pause cleaning.)

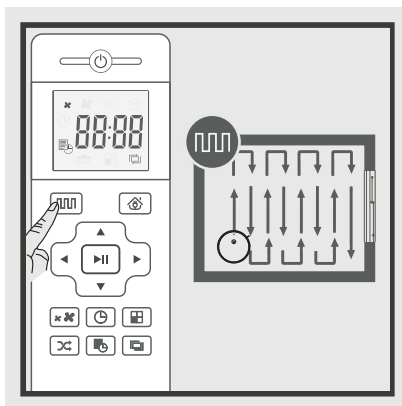

- \* Press button. The robot starts planning for cleaning and enters S-shape cleaning path automatically. During the cleaning process, it will automatically check where it doesn't clean and adjust its cleaning path appropriately, which is more efficient.
- \* The robot can independently plan a path during the working process. If you move it at side or operate it by a remote controller, the robot will re-plan the path, and the cleaned area may be re-cleaned. To ensure the working efficiency of the machine, do not arbitrarily control the robot.
- \* The robot will stop for a short time in the process of work (She is thinking about where she didn't clean and plan a new path). Please wait patiently. The times it pauses depend on the complexity of your home conditions.

#### 2 Random Mode

Press this button The device will perform random mode . When the sensor detects an obstacle or collides with an obstacle, it will change the route to avoid it.

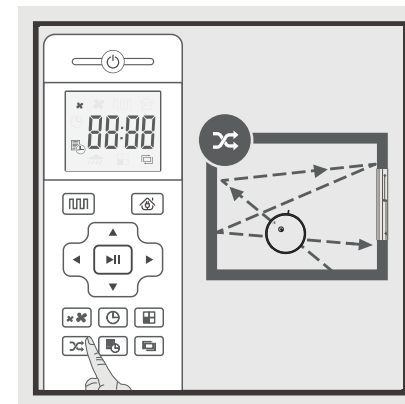

#### 3 Spiral cleaning mode

It is applicable to the floor environment where garbage is more concentrated. The machine carries out centralized vacuuming along a spiral route in the specified area, and returns to the original location after it has completed cleaning.

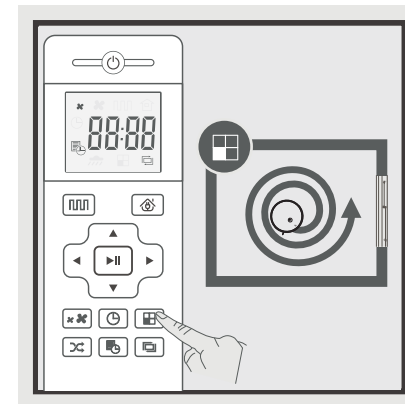

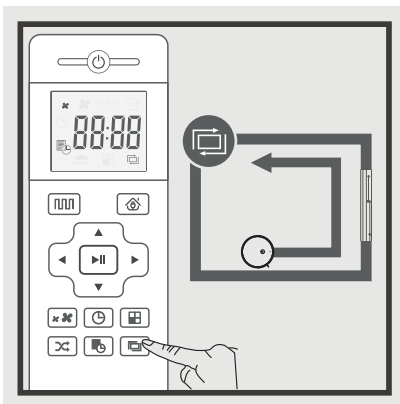

4 Edge cleaning mode 

Vacuum corners inside the house, and clean surrounding areas of any fixed object (such as wall), and return to the charging dock after completion.



5 Auto recharging mode 

Press  button on the remote controller or short press  button on the machine. The machine will start auto recharging mode. The charging dock shall be located in place as required and the power supply shall be connected properly.

During the cleaning process, the machine can detect low battery level in it, and then start auto recharging mode independently, and automatically locate the charging dock for charging.

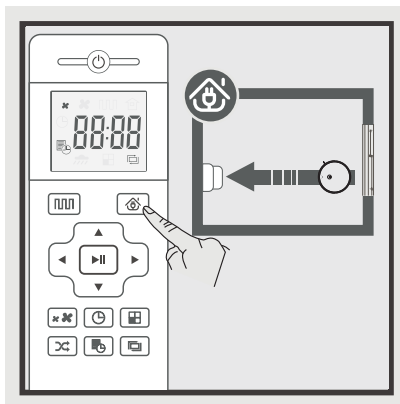

6 Suction power adjustment 

You can switch "Quiet/Powerful" suction power during operation by pressing  button.

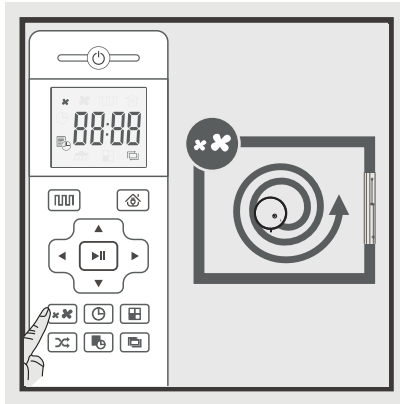

3.10 Operation of the water tank

This product is equipped with a water tank assembly. After completion of vacuuming, if you need to mop the floor, you can replace dust box with the water tank assembly. For instructions on cleaning of the water tank, refer to Section [Maintenance] in this manual.



- \* During mopping, if the machine suspends operation due to refilling of water or cleaning of mop, it will re-route the task and re-clean any cleaned area when it resumes. For better cleaning performance, it is recommended to use the machine to mop the floor in one room at one time.
- \* To vacuum a second room, it is recommended to move the machine to the target room manually and refill the tank or clean the mop as necessary.
- \* If more than one room needs to mop the floor, please refer to 2) above before cleaning.
- \* Do not use water tank assembly on carpet. When cleaning with mop function, please fold up the edge of carpet to avoid the carpet from being damaged by wet mop.
- \* During cleaning, please take much care to refill the water tank or clean mop in time. Remove the water tank when refilling it.
- \* When charging, be sure to remove the tank assembly.

1 Attach the mop

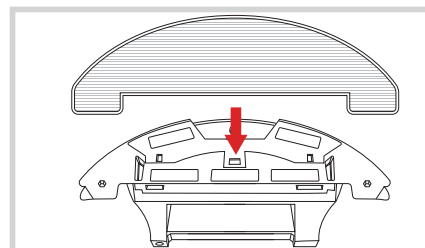

Fix the mop into the water tank and attach its corners to both sides of the tank, and mount it in place.

2 Refill the water tank

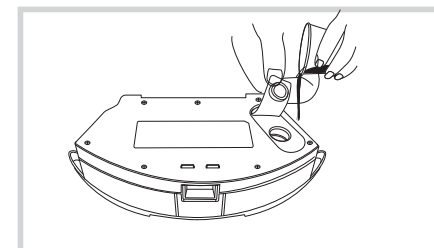

Remove the plug of the water inlet and slowly fill water into the tank. Then re-mount the glue plug in place.

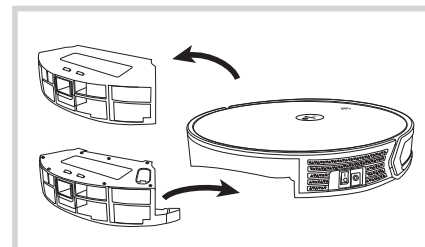

3 Install tank assembly

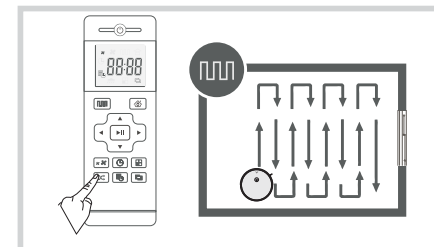

Remove the dust bin from the back end of the machine, and then insert the water tank into the empty slot.

4 Start mopping



Press  or  button on the remote controller, and the machine will start mopping.

## Maintenance

Prolong the service life

When cleaning and maintaining the machine and its accessories, please turn off the machine and unplug the power supply of the charging dock.

### 4.1 Clean the dust bin and filter elements

Take out the dust bin.

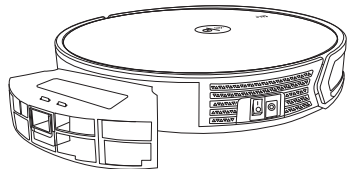

Open the dust bin lock, clean up the garbage.

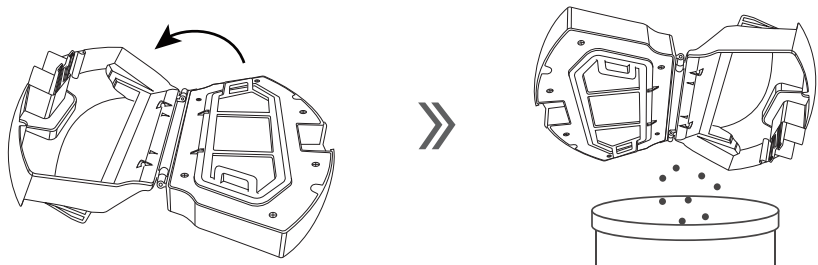

Remove the filter elements. You can wash the HEPA filter of gently pat it to remove the dust. After washing, allow it to air-dry before use.

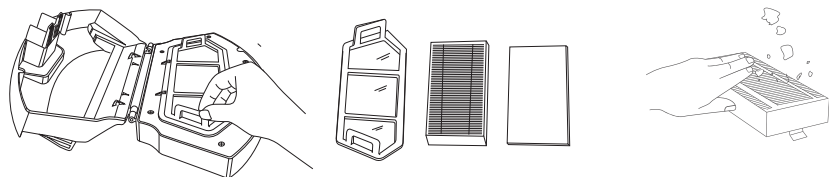

Wash the dust bin and the first filter element, dry the dust bin and filter elements. Keep them dry can prolong their service life.

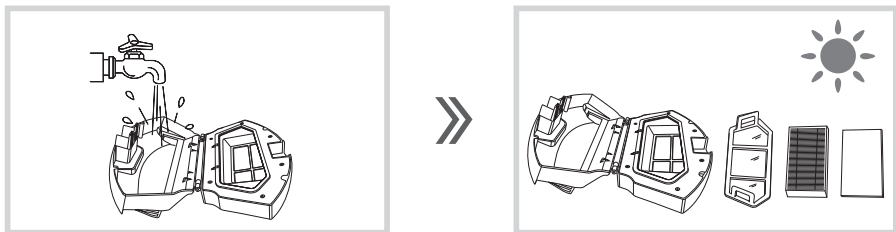

## Maintenance

Prolong the service life

### 4.2 Clean the water tank

#### 1 Clean the mop

Disassembly: after mopping floor, first remove the water tank, and then remove the mop support and mop.

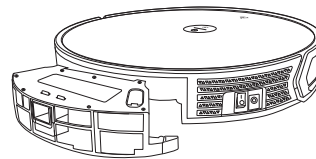

Maintenance: Wash and dry the mop.

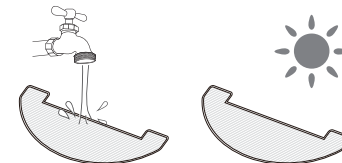

#### 2 Clean the water tank

Disassembly: After mopping floor, remove the tank assembly and remove the mop, and empty the tank.

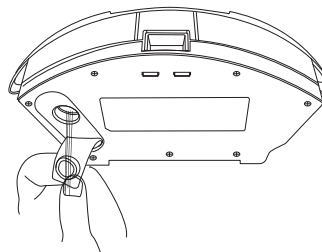

Maintenance: Clean and dry the water tank in air.

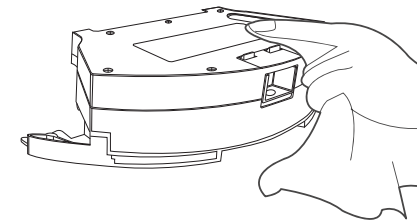

### 4.3 Clean the other components

#### 1 Clean the side brush

Remove the side brush and wipe it with a clean cloth.

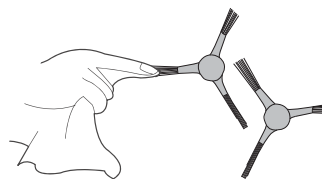

#### 2 Clean the universal caster

Remove hairs from the universal caster.

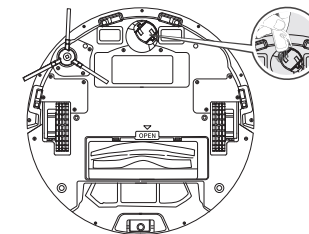

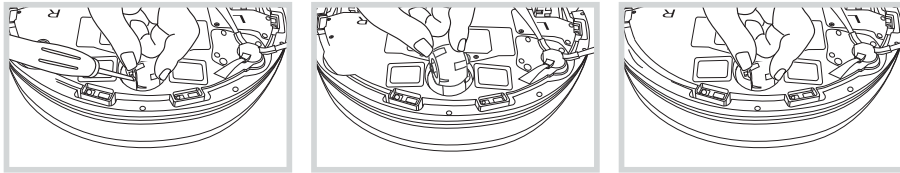

Step 1: carefully pry out the universal caster with a slotted screwdriver.

Step 2: Remove the universal caster, and clean the hair around the universal caster.

Step 3: put the universal caster back to the installed position and press it down.

**5 Clean the cliff sensor**

Clean the cliff sensor to ensure sensor sensitivity.

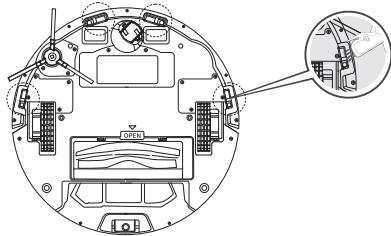

**6 Clean the infrared sensor lens**

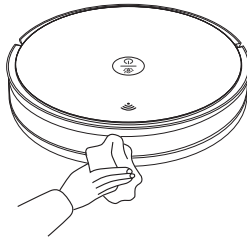

**7 Clean the rolling brush intake port**

In case there's a lot of hair stuck in rolling brush, please clean it with a small tool.

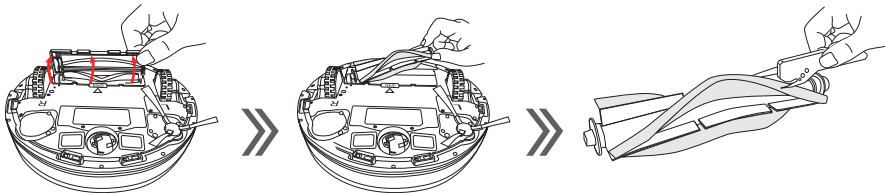

**8 Clean the charging electrode**

Please use a dry cloth to clean the bottom of the machine and the charging electrode on the charging dock.



**5.1 Indicator description**

Status	Display
Charging	Breathing red light
Battery is full charge	Green light always on
Machine malfunctions	Red light always on
Low battery	Red light always on
Cleaning mode	Green light always on

When something goes wrong with the machine, the red light will be always on, and the voice prompts at the same time. You can move the machine position and turn off the power switch of the machine, then restart it.

**5.2 Audible alarms list**

When the machine fails, the red light will be flashing red or stays on, and voice alarm will be heard.

**Red light always on**

No.	Prompt tone	Cause	Fault prompt on the APP and solution
1	1 beep	Drive wheel fails	Drive wheel fails. Check the caster if it is stuck and clean the drive wheel.
2	2 beeps	Battery charging fails	Battery charging fails. Clean the machine and charging electrode on the charging dock. Make sure to use the original adapter.
3	3 beeps	Abnormal fan	Abnormal fan. Clean the dust bin, air inlet and filter elements.
4	4 beeps	Gyroscope fails	Contact after-sales service
5	5 beeps	Rolling brush fails	Rolling brush fails. Remove hairs and foreign matter from the rolling brush.

**Red light flashing**

No.	Prompt tone	Cause	Fault prompt on the APP and solution
1	1 beep	Bumper fails	Check the bumper if it is stuck and remove foreign matter.
2	2 beeps	Side brush fails	Check the side brush if it is stuck by hairs and remove hairs.
3	3 beeps	Cliff sensor alarm	Check the cliff sensor if there is dirty mark and clean it with a cloth.
4	4 beeps	Low battery	Low battery. Please charge.
5	5 beeps	Magnetic stripe fails	Contact after-sales service

**\* Warm tips**

If the above method does not solve the problem, please try the following:

1. Power off and power on. Restart the machine.
2. If the problem cannot be solved by restarting the machine, please send the machine to the after-sales service center for maintenance.



## Trouble Shooting

### Problem solving

If the problem occurs during operation, please check the following table to find a solution.

No.	Fault Condition	Possible Reasons	Solution
1	Robot fails to connect the APP	Wrong router user name and password.	Reset the correct router user name and password
		Robot is not in network signal range.	Make sure the robot is in network signal range
		Robot is not configured.	Configure the network for the robot.
		Robot does not connect to 2.4GHz network	Robot can not connect to 5GHz network, please connect to 2.4GHz network.
2	Robot fails to charge	The adapter is not the original model.	The original adapter model should be used.
		Poor charging electrode contact when placing robot on the charging dock.	Ensure that the robot and the charging electrode are fully plugged in place. Check whether the charging electrode and the machine are dirty and it should be cleaned by referring to the Maintenance instructions.
		The charging dock is not connected to the power supply.	Make sure that the charging dock and the power supply is connected.
		Long-term non-use leads to battery overdischarge.	If it is not used for a long time and cause the battery can not be charged, please contact after-sales service personnel.
3	Robot fails to recharge	The charging dock is placed incorrectly.	Place the charging dock correctly according to the Charging method.
		The charging dock is powered off or manually moved.	Please check whether the charging dock is connected to the power supply. Do not move the charging dock.
		The machine is stuck by ground obstacles (such as wires, carpet corners, electric fan base, etc.) or the door of the room with the charging dock is closed, which makes it impossible to return to the charging dock.	It is recommended to remove the ground objects with reference to the Precautions before using the robot to ensure smooth running. Avoid jamming and keep the recharging route smooth.
		The main engine did not start cleaning from the charging stand.	It is recommended that the robot start cleaning from the location of the charging dock.
4	When the robot is working, there are situations such as disorderly route, deviation, repeated cleaning and small areas fails to get cleaned up.	Wires, slippers and other objects placed on the ground affect the normal operation of the robot.	Please arrange scattered wires, slippers and other objects on the ground before the robot works. In case of areas fails to get cleaned up, the robot will automatically detect the area and complete the cleaning, please do not intervene manually (such as moving the robot or blocking the robot's working route).
		Working on the newly waxed and polished floor reduces the friction between the driving wheel and the ground.	It is recommended to use the robot after the floor wax is dry.
		Due to different home environments, the robot cannot perform cleaning in some area.	It is suggested to arrange the home environment to ensure that the robot can work on the floor.
5	Robot is stuck during operation	The robot is entangled or obstructed by scattered wires, drooping curtain cloth, carpet whisker, etc. on the ground.	The robot will try to get out of trouble independently. If it fails to get out of trouble, it is recommended to help manually.
		The robot may be stuck by furniture which its bottom height is similar to that of the robot.	It is suggested that furniture should be raised or sheltered artificially.
6	When the robot is working, the running sound is loud	Side brushes are entangled, dust bin and filter materials are blocked, etc.	It is recommended to clean and maintain the side brushes, dust bin and filter materials regularly.
		The rolling brush is entangled with hair.	Remove the hair sewed on the rolling brush.
7	Rolling brush does not rotate	Rolling brush and rolling brush shield are installed incorrectly.	Reinstall the rolling brush assembly.
		The rolling brush assembly sucks in foreign matter.	Disassemble the assembly and remove the foreign matter from the rolling brush assembly.
		Low battery of the remote controller .	Replace the battery.
8	Remote control failure	The robot is turned off or low battery of the robot.	Ensure that the machine power switch is turned on and the battery is full.

## Name and content of hazardous substances in product

9	Robot fails to start	The robot is out of power or the power switch is off.	Please charge the robot or turn on the power switch.
	Robot shakes when running	Side brush or caster tangled with hair.	Please remove hairs from the side brush or the universal wheel.
	Abnormal operating condition	The intake port is blocked or the dust bin is full.	Please check the suction port and clean the dust bin.
		HEPA is blocked.	Clean or replace the HEPA
	Water not coming out.	The outlet hole of the water tank is blocked or the water tank has no water.	Please blow the water outlet and fill it with water.
		The pump does not work.	Please contact our company for after-sales maintenance.
Machine skid	The ground is too wet.	Please wring out the mop cloth and clean the water stains on the floor.	
Machine keeps going backwards	Abnormal cliff sensor	Please clean the surface of the cliff sensor.	

If the problems cannot be solved according to the above operation, please contact the after-sales service.

\*V6S contains radio transmission module with model approval code: CMIIT ID: 2018DP483

\* This product is subject to the material object, and our company reserves the right to update the product without prior notice.

Component Name	Component Name					
	Lead (Pb)	Mercury (Hg)	Cadmium (Cd)	Chromium VI (Cr(VI))	Polybrominated biphenyls (PBB)	Polybrominated diphenyl ethers (PBDE)
Plastic parts	O	O	O	O	O	O
Hardware	X	O	O	O	O	O
Circuit block	X	O	O	O	O	O
Battery	O	O	O	O	O	O
Plug, power cable (metal)	X	O	O	O	O	O

O: indicates that the content of the hazardous substance in all homogeneous materials of the part conform to the limit stipulated in the current effective version of GB/T26572.

X: indicates that the harmful substance contained in at least one homogeneous material of the component exceeds the limit stipulated by the current effective version GB/T26572, and there is no mature alternative plan in the industry, which conforms to the environmental protection requirements of EU ROHS directive.



The number in this logo indicates that the environmental protection service life of the product is 10 years under normal and practical conditions.

### Executive standard

GB4706.1-2005 GB4706.7-2014  
GB4343.1-2018 GB-17625.1-2012



## Battery recycling

### Steps to remove the battery

1. For purpose of environmental protection, user shall dispose this product in compliance with the current national or regional laws and regulations on disposal of waste electrical and electronic products, or transfer this product to a local approved recycling/disposal agency.

2. The battery of the robot shall be removed and disposed safely in accordance with the following procedure only by a qualified full-time engineer of an approved recycling/disposal agency.

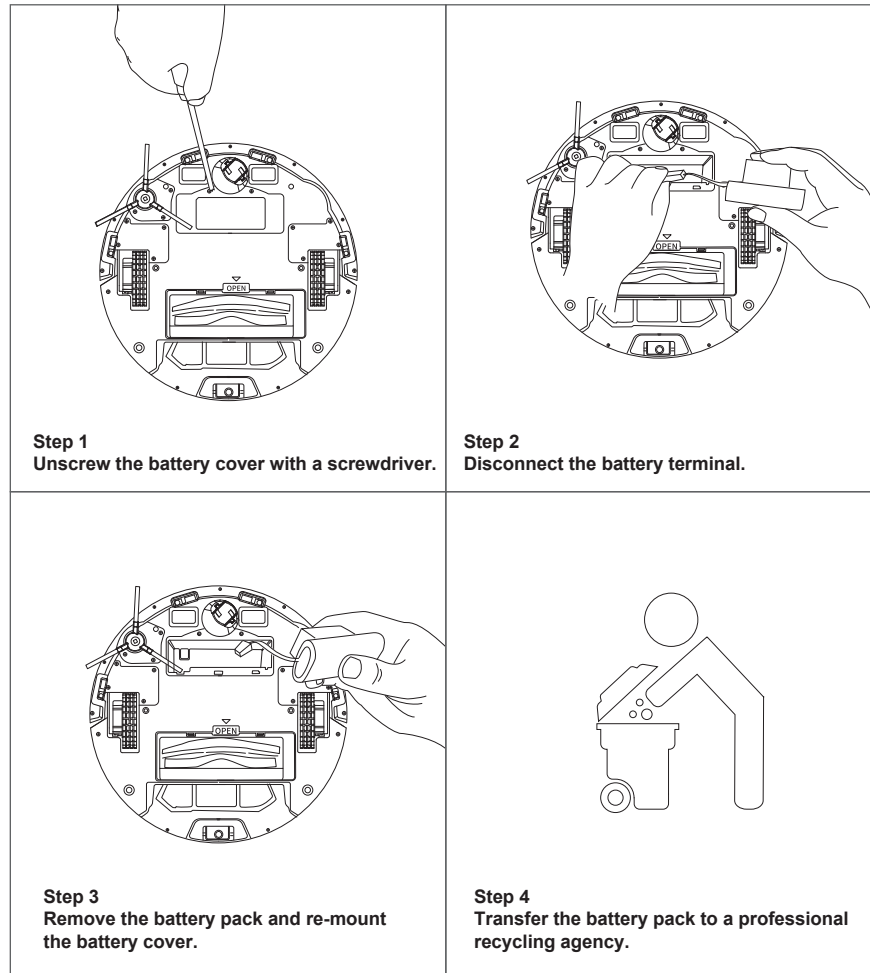

*Delton*

1141 Budapest, Fogarasi út 77.      1095 Budapest, Mester utca 34.  
Tel.: \*220-7940, 220-7814, 220-7959,      Tel.: \*218-5542, 215-9771, 215-7550,  
220-8881, 364-3428 Fax: 220-7940      216-7017, 216-7018 Fax: 218-5542  
Mobil: 30 531-5454, 30 939-9989      Mobil: 30 940-1970, 30 959-0930

**www.robotol.hu**

E-mail: [info@delton.hu](mailto:info@delton.hu) Web: [www.delton.hu](http://www.delton.hu)